

Rolling Garage Door Opener

Installation Instructions And User Guide

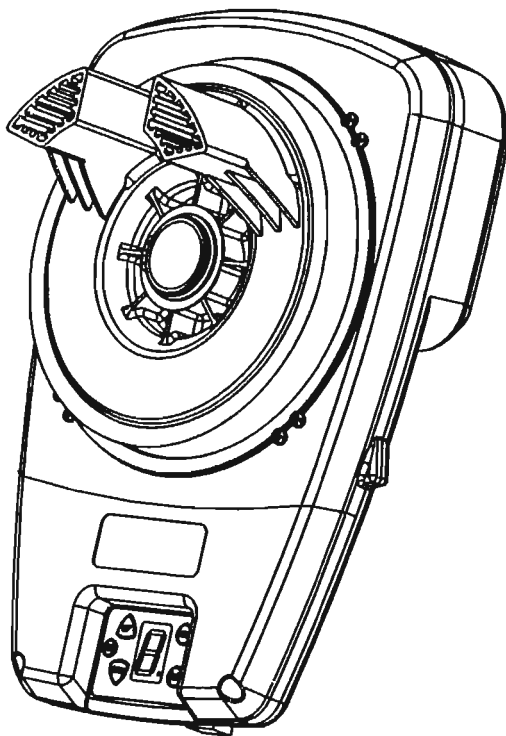

VR660M/VR880M/VR1100M/VR1800M

WARNING

Please read the manual carefully before installation and use. The installation of your new door opener must be carried out by a technically qualified or licensed person. Attempting to install or repair the door opener without suitable technical qualification may result in severe personal injury, death and / or property damage.

START BY READING THESE IMPORTANT SAFETY INSTRUCTIONS

WARNING

- Failure to comply with the following instructions may result in serious personal injury or property damage.
- Read and follow all instructions carefully.
- The garage door opener is designed and tested to offer safe service provided it is installed and operated in strict accordance with the instructions in this manual.

These safety alert symbols mean **WARNING** : A possible risk to personal safety or property damage exists.

1. **Keep garage door balanced.** Do not let the garage door opener compensate for a binding or sticking garage door. Sticking, binding or unbalanced doors must be repaired before installing this opener.

2. **Do not wear rings, watches or loose clothing.** while installing or servicing a garage door opener. Wear gloves and

suitable protective clothing where appropriate.

3. Frequently examine the door installation, in particular cable, springs and mountings for signs of wear, damage or imbalance. Do not use if repair or adjustment is needed since springs and hardware are under extreme tension and a fault can cause serious personal injury.

4. To avoid serious personal injury from entanglement, **remove all ropes, chains and locks connected to the garage door** before installing the door opener.

5. Installation and wiring must be in compliance with your local building and electrical codes.

6. The safety reverse system test is very important. Your garage door **MUST** reverse on contact with a 40 mm obstacle placed on the floor. Failure to properly adjust the opener may result in serious personal injury from a closing garage door. **Repeat the test once a month and make any necessary adjustments.**

7. This appliance is not intended for use by persons (including children) with reduced physical, sensory or mental capabilities, or lack of experience and knowledge, unless they have been given supervision or instruction concerning use of the appliance by a person responsible for their safety.

8. Automatic Drive - Keep away from the area of the door as it may operate unexpectedly.

9. This opener should not be installed in a damp or wet space exposed to weather.

10. The opener must not be used on a wicket door (door within a door).

11. The Protector System™ must be used for all installations where the closing force as measured on the bottom of the door is over 400 N (40 kgf). Excessive force will interfere with the proper operation of the safety reverse system or damage the garage door.

12. After installation, ensure that the parts of the door do not extend over public footpaths or roads.

13. Install the wireless wall control (or any additional wall control) ***in a location where the garage door is visible, at a height of at least 1.5 m and out of the reach of children. Do not allow children to operate push button(s) or transmitter(s).*** Serious personal injury from a closing garage door may result from misuse of the opener.

14. ***Permanently fasten the Warning Labels in prominent places,*** adjacent to wall controls and manual release mechanisms as a reminder of safe operating procedures.

15. ***Activate opener only when the door is in full view, free of obstructions and the opener is properly adjusted. No one should enter or leave the garage while the door is in motion.***

16. ***Do not allow children to play near the door, or with door controls.***

17. If the supply cord is damaged, it must be replaced by the manufacturer, its service agent or similarly qualified persons

in order to avoid hazard.

18. Disconnect electric power and battery to the garage door opener before making repairs or removing covers.

KEEP THESE INSTRUCTIONS

CONTENTS	PAGE
SAFETY INSTRUCTIONS	1-5
PACKING LIST	6
TOOLS REQUIRED	6
DOOR REQUIREMENTS	6
TESTING THE DOOR	7
INSTALLING THE STOP COLLAR	7
INSTALLING THE WEIGHT BAR (PROVIDED)	7
THE RELEASE HANDLE & CORD	8
OPERATING THE MANUAL RELEASE	8
PINNING THE DOOR	9
ATTACHING EXTENSION POLES (IF REQUIRED)	9
LEFT / RIGHT HAND INSTALLATION	9
INSTALLATION PROCEDURE	10-11
BASIC FUNCTION SETTING AND APPLYING	11-13
<i>Matching the receiver and transmitter</i>	<i>11</i>
<i>Travel limit setting Opening & closing force self-learning</i>	<i>11</i>
<i>Safety reverse force adjustment</i>	<i>12</i>

CONTENTS	PAGE
IR Beam setting	12
Auto-close setting	12
Installation direction setting	13
Lock door setting(Optional function)	13
Half-open setting(Optional function)	13
Alarm and maintenance function	13
TESTING THE SAFETY REVERSE SYSTEM	14
FIXING WARNING LABELS	14
INSTALL THE IR BEAMS (OPTIONAL ACCESSORY)	15
INSTALL UNIVERSAL RECEIVER(OPTIONAL ACCESSORY)	15
INSTALL THE FLASH LIGHT(OPTIONAL ACCESSORY)	16
MAINTENANCE	16
FINAL NOTES	16
IMPORTANT INFORMATION FOR THE USER	17
TECHNICAL SPECIFICATIONS	17
COMMON FAULT & SOLUTIONS	18

1.Packing List









Standard list :

- 1.Rolling garage door opener X 1;
- 2.Remote control X 2;
- 3.Instructions X 1;
- 4.Clutch pull rope X 1;
- 5.Warning Label X 1;

Selection list:

- 1.Weight bar X 1;
- 2.Wall switch X 1;
- 3.Extension pole bag X 1;

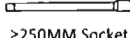
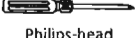
2.TOOLS REQUIRED

				
Ladder	Socket wrench	Adjustable Wrench	Drill	Marker Pen
				
13MM Socket	≥250MM Socket Extension	Philips-head Screwdriver	6.5MM Drill Bit	

3.DOOR REQUIREMENTS

The maximum allowable door height is 5.5m. The door must be of continuous corrugated sheet construction and spring balanced. Door axle diameter must not exceed 35mm.

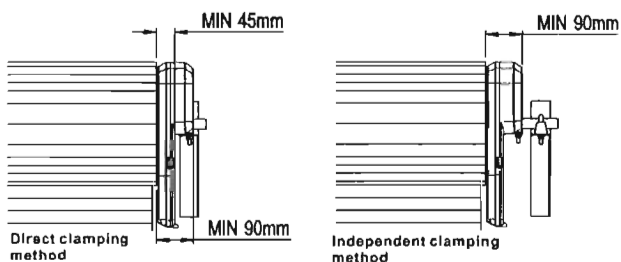

Ensure that there is at least 45 mm from the edge of the curtain to the edge of the bracket. If the roller door drum is on the edge of the curtain or is a smaller diameter, additional clearance may be required.

If the drum is more than 60 mm from the curtain edge or of a smaller diameter, an extension pole kit may be required (section 10).

Ensure there is a power point near the opener.

4. TESTING THE DOOR

Complete the following test to ensure your door is well balanced, and not sticking or binding:

- Disable all locks and remove any ropes connected to the garage door.

- Lift the door to about halfway and then release it.

The door should remain spring balanced.

- Raise and lower the door to determine if there are any sticking or binding points (20 kgf is the absolute maximum allowable to raise or lower the door in any position).

- If your door does not hold in place or the door binds or sticks, call a qualified door technician before installing the opener.

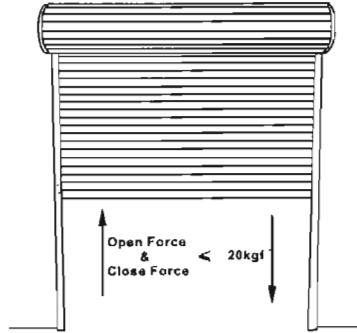

5. INSTALLING THE STOP COLLAR

- Install the stop collar on the opposite end to where the opener is to be installed.

- Fit the stop collar hard against the boss of the door drum. Ensure the U-bolt holding the door shaft to the door bracket is tightly secured.

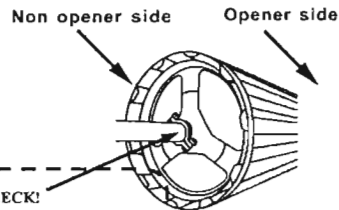

SAFETY CHECK!

Is the stop collar installed?

YES: proceed to the next step

NO: install the stop collar before proceeding

6. INSTALLING THE WEIGHT BAR (PROVIDED)

- Place the weight in the centre of the door (as shown).

- Use a pencil to mark the two hole positions.

- If the door curtain does not have a handle you will need to drill two 6.5 mm holes through the two marked positions, then place the weight bar on the inside of the door.

- Use the bolts and nuts (provided) to fasten the weight bar in place.

NOTE: If the door has a lifting handle, remove the handle, nuts & bolts. Place weight bar over the handle holes, insert extended bolts through the weight bar & fasten handle back in place.

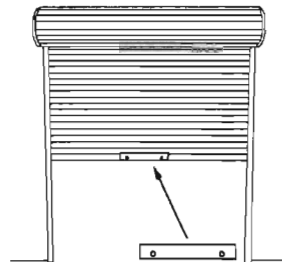

12. INSTALLATION PROCEDURE

Do not allow people to walk under or around the door during the installation process as serious injury can occur.

NOTE: The opener can be installed on either side of the door. The following instructions are for **RIGHT HAND INSTALLATIONS** (as illustrated i.e. inside the garage looking out). For left hand installations, reverse the instruction terminology (eg **LEFT** for **RIGHT** etc).

Preparation:

- Place the opener in manual release mode (refer section 8).
- Open the roller door fully. For safety, tie a rope around the door.
- Ensure the door axle U-BOLT and door mounting bracket on the left hand side (non opener side) are securely fastened.
- Support the door with a door stand or similar device to safely support the door.
- Mark the position of the door shaft on the right hand door bracket (for reassembly purposes).
- While the door is supported, remove the right hand axle U-Bolt and door mounting bracket from the wall.

Install the opener:

- Slide the opener over the door axle and engage the drive legs into the door drum wheel, either side of a spoke. Extensions may be necessary (refer section 10).
- Refit the door mounting bracket to the wall. If the door bracket needs to be relocated due to opener width, refer section 3.
- Clamp the opener on the door axle and door bracket in the marked position using the clamp assembly supplied (tighten to 25 – 28 Nm).
- If side room exceeds 95mm clamp independently to the door axle as illustrated in section 3.
- Remove all ropes and the support stand.
- Check the operation of the door in manual mode by raising and lowering by hand. It should operate smoothly without sticking or binding. The disengage handle should already be attached less than 1.8m above the floor (refer section 4 and section 7).

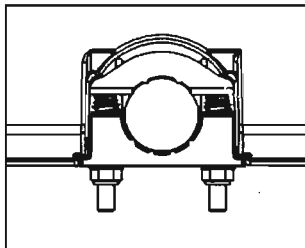
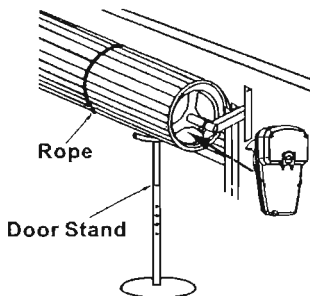
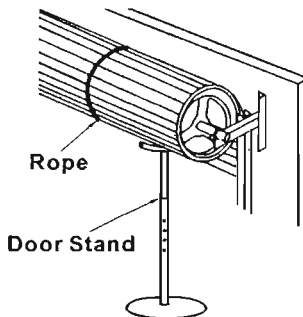

Tighten To 25-28Nm

7. THE RELEASE HANDLE & CORD

- Thread one end of the rope through the hole in the top of the red release handle so that "NOTICE" reads right side up as shown.
- Secure with an overhand knot at least 25 mm from the end of the rope to prevent slipping.
- Thread the other end of the rope through the loop of the manual release cable.
- Adjust rope length so the handle (when installed) will be no higher than 1.8 m above the floor. Secure with an overhand knot.

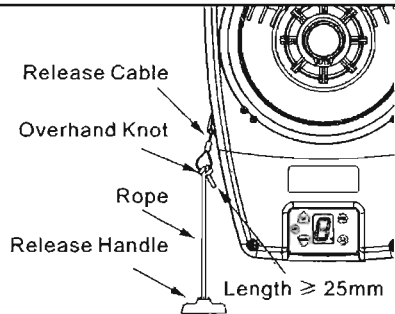

Overhand Knot

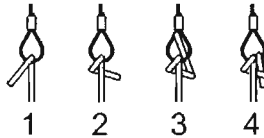

NOTE: Final adjustment of handle height should be completed after the opener is installed. If it is necessary to cut the rope, heat seal the cut end to prevent unravelling.

8. OPERATING THE MANUAL RELEASE

To disengage the opener
Pull the release cord down firmly:

To re-engage the opener
Pull the release cord down firmly:

NOTE:

Disable all locks and remove any ropes connected to the garage door.

Take care when operating the manual release as an open door may fall rapidly due to weak or broken springs, or being out of balance.

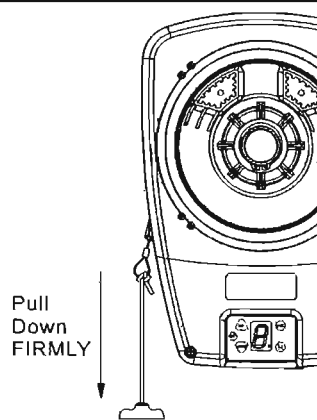

9. PINNING THE DOOR

Note: A ballooning door may delay the safety reversal response and can compromise garage door security.

- To remedy any ballooning place self tapping metal screws or rivets where the curtain leaves the roll. Secure these through the curtain into the drum wheel at each end of the roll.

- After determining the correct fastener location as shown, lift the door approximately half a turn from the closed position to allow access for drilling.

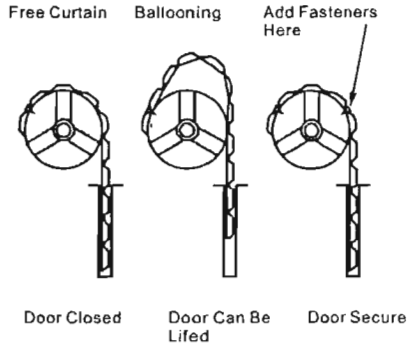

10. ATTACHING EXTENSION POLES (IF REQUIRED)

Optional accessory not provided

- Align the extension pole holes with the drive legs.
- Slide the reinforcing brace over the poles.
- Insert the extension poles into the drive leg and fix in place using screws provided.

*** Reinforcing brace must be used.**

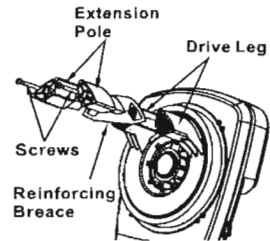

11. LEFT / RIGHT HAND INSTALLATION

LEFT

(Handing must be changed during limit setting, section 13.6)

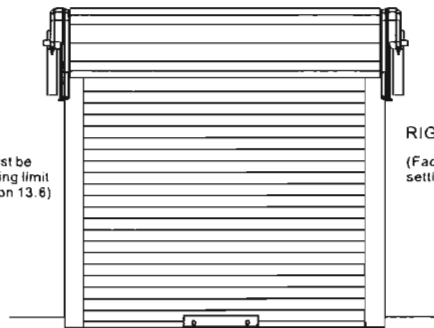

RIGHT

(Factory default setting)

Inside garage looking out

Connect the power:

- Position the power cable away from the door curtain and any moving parts.
- Plug the opener into a nearby power point and turn ON.
- The opener courtesy LEDs should turn ON.
- The opener must now be programmed for :
 - 1.DOOR TRAVEL LIMITS (Section 13.2)
 - 2.RIGHT OR LEFT HAND OPERATION (Section 13.6)
 - 3.FORCE SETTING (Section 13.3)

13. BASIC FUNCTION SETTING AND APPLYING

13.1 Matching the receiver and transmitter

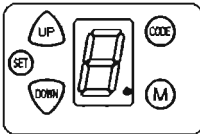

Coding Transmitters:

Press and hold on "Code" button for 1 second until the led dot is on. Press button on transmitter once, the dot will go off, press the same transmitter button again and the dot will flash fast for 8 times, and then return to standby mode. The transmitter is now coded into the receiver. Repeat the above steps to code more transmitters. The receiver has the

capacity to store 20 transmitters.

If the led display flashes "F" and returns to standby mode (after you have pressed the Code button), this indicates that the memory storage is full (20 transmitters). Follow the steps below to delete all transmitters that are stored in the receiver memory: Press and hold on "CODE" button for more than 8 seconds until the LED flashes "C" , all the stored codes are deleted. Only the matched switch on the transmitter is available.

NOTE: If failed to match the transmitter within 20 seconds, then it will return to standby mode automatically.

13.2 Travel limit setting Opening & closing force self-learning

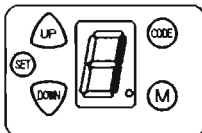

Press and hold on "SET" button for 3 seconds until the LED flashes "1". Press "SET" button again for 1 second . "1" should now display as steady (not flashing).

Then adjust the up limit by pressing "UP" button.

Fine-tuning "UP" or "DOWN" button to determine the final up limit

position (the LED flashes "n" or "u" during opening or closing), then press "SET" button, the display turn into "2" automatically.

Adjust the down limit by pressing "DOWN" button.

Fine - tuning "UP" or "DOWN" button to determine the final down limit position (the LED flashes "n" or "u" during opening or closing), then press "SET" button.

When press button to operate the opener, if the opener stops after operate a little, and LED flashes "H" or "C", this indicates there's no hall signal or the opener is overload.

The opener will operate a cycle automatically to remember the limit positions and the original pening & closing force, then return to standby mode.

During learning, if the door stops unusually, and flashes "E", "C", "O", "L" for 5 seconds, this indicates there's no hall signal, overload, overtime, wrong limit setting.

13.3 Safety reverse force adjustment

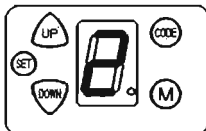

Press and hold on "SET" button for 3 seconds until the LED flashes "1". Press "UP" or "DOWN" button until LED flashes "2", then press "SET" button. It's now under force adjustment mode. The LED displays the current set force.

Press "UP" button to increase the force and "DOWN" button to decrease the force. The maximum force is 9 and the minimum is 1. Press "SET" button to confirm, then the opener returns to standby mode.

The default setting of safety reverse force is 3.

13.4 IR Beam setting

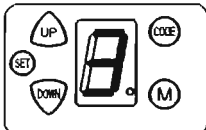

Press and hold on "SET" button for 3 seconds until the LED flashes "1". Press "UP" or "DOWN" button until the LED flashes "3", press "SET" button. It's now under IR Beam setting mode. The LED displays the current setting.

Press "UP" button, the LED displays "1", the IR Beam Function is available. Press "DOWN" button, the LED displays "0" to cancel this function. Press "SET" button to confirm. The opener returns to standby mode.

The default setting of IR Beam is "0".

Notice:

- Close the IR Beam function when you don't use IR Beam sensor.
- We urge you to consider fitting IR Beams to your new garage door opener. In many countries these devices are compulsory to assist in preventing serious injury or property damage. For your own peace of mind and the safety of others please install this inexpensive safety device.

13.5 Auto-close setting

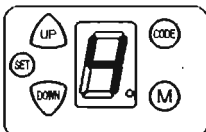

Press and hold on "SET" button for 3 seconds until the LED flashes "1". Press "UP" or "DOWN" to increase or decrease, adjust the LED to flash "4", then press "SET" button to enter into auto-close setting, the LED displays the current setting.

Press "UP" or "DOWN" button to adjust the auto-close time. Press "UP" button once, the auto-close time will increase 1 minute, the maximum time is 9 minutes. Press "DOWN" button once, the auto-close time decrease 1 minute. The auto-close function will be turned off when the LED displays "0". Press "SET" button to confirm, the opener returns to standby mode.

The auto-close function can only be available when the door is fully open and the IR Beam function is on.

The default setting is "0".

13.6 Installation direction setting

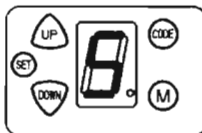

Press and hold on "SET" button for 3 seconds until the LED flashes "1". Press "UP" or "DOWN" to increase or decrease, adjust the LED to flash "5", then press "SET" button.

It displays "R" or "L", hold down the "UP" or "Down" button, you can switch directly. Choose the function which you need, press the "SET"

button, the LED displays the current setting.

NOTE: "L" means left installation, "R" means right installation.

13.7 Lock door setting(Optional function)

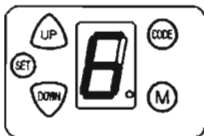

(Only when the lock door function is available, the setting can be proceed. The "lock" key can not be matched)

Press and hold on "SET" button for 3 seconds until the LED flashes "1". Press "UP" or "DOWN" button to increase or decrease. Adjust the LED to flash "6", press "SET" button to enter into lock door setting. The LED

displays the current setting.

Press "UP" button, the LED displays "1", the lock door function is on. Press "DOWN" button, the LED displays "0", the lock door function is off. Press "SET" button to confirm, the opener returns to standby mode.

When the lock door function is on and the door is fully closed, the opener will lock the door automatically. And then the door can only be opened by transmitter after unlocked by the "lock" key(S2) on the transmitter. (If not unlocked by the S2 button on the transmitter, the light will flash twice when press the open key on the transmitter)

The default setting is: invalid.

13.8 Half-open setting(Optional function)

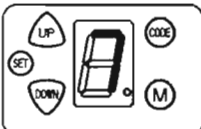

(Only when the half-open function is available, the setting can be proceed. The half-open key on the transmitter can not be matched)

Press and hold on "SET" button for 3 seconds until the LED flashes "1". Press "UP" or "DOWN" button to increase or decrease. Adjust the LED to flash "7". Press "SET" button to enter into half-open setting. The LED

displays the current setting.

Press "UP" or "DOWN" button to increase or decrease. When the LED displays "1", the half-open height is 30cm. When the LED displays "2", the half-open height is 60cm. When the LED displays "3", the half-open height is 90cm. When the LED displays "0", the half-open function is off. Press "SET" button to confirm, the opener returns to standby mode.

If the half-open function is on, only when the door is fully closed, the door can half-open by the "S1" key on the transmitter. If the door is at other position, the "S1" key will not work.

The default setting is : invalid.

13.9 9. Alarm and maintenance function

When the LED flash, displaying "A", which means opener working circles exceeds the maximum safety and need for maintenance, suggest you contact the maintainers .

14. TESTING THE SAFETY REVERSE SYSTEM

The safety reverse system test is important.

The garage door must reverse on contact with a 40 mm obstacle laid flat on the floor.

Failure to properly adjust the opener may result in serious personal injury from a closing garage door.

Operate the door in the down direction. The door must reverse upon contact with the obstacle. If the door stops on the obstacle, remove obstacle and repeat limit and force setting (refer section 13.3).

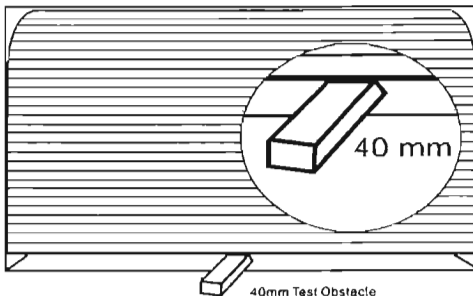

Repeat test of the safety reverse system.

15. FIXING WARNING LABELS

Once you have completed your installation and successfully carried out the safety reverse system test (outlined above), install the warning labels provided with your opener as shown.

The **WARNING** label must be installed in a prominent place near any fixed control.

Any fixed wall control or wireless door control must be mounted at a height of no less than 1.5 m out of the reach of children.

Read the safety instructions (page 1) for further details concerning safety.

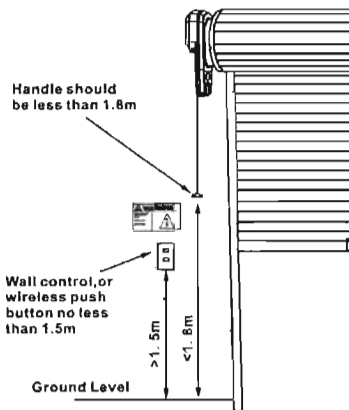

16. INSTALL THE IR BEAMS (OPTIONAL ACCESSORY)

NOTE: This accessory must be used for all installations where the closing force as measured on the bottom of the door is over 400 N (40 kgf).

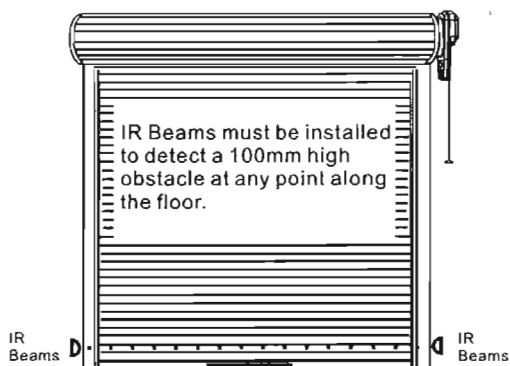

ENABLING THE PROTECTOR SYSTEM: (Section 13.4)

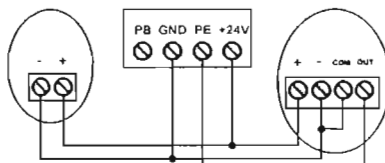

*** Door may operate unexpectedly, therefore do not allow anything to stay in the path of the door.**

17. INSTALL UNIVERSAL RECEIVER (OPTIONAL ACCESSORY)

Install the line wall button and universal receiver (Refer Section 15)

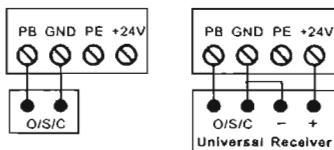

18. INSTALL THE FLASH LIGHT (OPTIONAL ACCESSORY)

Can only use 24V DC Flash Light.

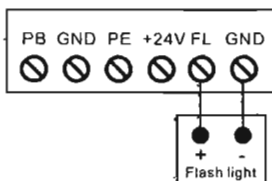

19. MAINTENANCE

No particular maintenance is required for the logic circuit board.

Check the door at least twice a year if it is properly balanced, and all working parts are in good working condition or not.

Check the reversing sensitivity at least twice a year, and adjust if it is necessary.

Make sure that the safety devices are working effectively (IR Beams, etc.)

Notice: A rude operating door can affect the life of the automatic opener due to incorrect loads, and will void the warranty.

20. FINAL NOTES

This manual is only used by technical persons who are qualified to carry out the installation.

No given information in this manual can be considered of any interest to the end user.

It is important for the installer to show their clients correct operation using of the opener including the using of manual disengagement cord.

Inform the owner about the need of a regular and accurate maintenance, especially regarding a regular check of the safety and reversing devices.

21. IMPORTANT INFORMATION FOR THE USER

Once the opener has been installed, the user must be informed about how it works and all the risks that can arise if it is used improperly. The user must avoid placing himself/herself in dangerous situations such as standing within the door's operating range when it is moving.

Do not let children play near the door, and keep the remote controls out of their reach.

All services, repairs or checks must be carried out by professionally qualified persons, and noted on a maintenance register kept by the user.

IMPORTANT NOTE: In the case of a malfunction the user must call an authorized installer and should not attempt to repair it by yourself.

22. TECHNICAL SPECIFICATIONS

Model	VR660M	VR880M	VR1100M	VR1800M
Opening Speed	200MM/S	200MM/S	200MM/S	130MM/S
Rated Lifting Weight	35KGS(350N)	40KGS(400N)	45KGS(450N)	90KGS(900N)
Max Lifting Force	600N	800N	1000N	1800N
Rated door area	18 m ²	20 m ²	22 m ²	28 m ²
Max door weight	100kgs	110kgs	120kgs	300kgs
Drum Rotations	5.5			
Power Supply	220VAC-240VAC/50Hz -60Hz ; 110VAC-127VAC/50Hz-60Hz			
Motor Type	24V DC permanent magnet			
General working time	≤60s			
Working Temperature	-20°C - +50°C			
Transmitter Frequency	433.92MHz			
Coding Type	Rolling code			
Coding Combination	Over 4.29 billion			
Lights	24V / 12pcs LED bulbs			

COMMON FAULT & SOLUTIONS		
Fault appearance	Fault cause	Solutions
Opener without any action	1. Power supply 2. Plug wire are loosening	1. Check the power supply to openers. 2. Carefully open the motor cover, check all plug wire on control boards.
Opener doesn't work, LED displays "-"	Faulty learning of "UP" or "DOWN" travel limit	Learn "UP" and "DOWN" travel limit again follow the manual
The door can only open, can not close	In operation with IR Beam. Or IR Beam function is available but with no IR Beam connected.	Check IR Beam, move away the obstruction. Cancel the IR Beam function if there's no IR Beam connected. (follow the instruction manual)
Open and close action is reversed	Reversed connection of the positive and negative of motor wire to the control board.	* Power off firstly, open the motor cover and reverse the positive and negative of motor wire on the control board. Re-set the travel limit.
Door auto reverse to full open before closed completely	In operation with safety reverse function. Because some old doors with not well balanced springs or there's some block	1. Check the door springs or any blocks 2. Re-set the travel limit. 3. Increase the force value of safety reverse.
Transmitter doesn't work	1. Flat battery 2. Antenna is loosed or not well extended 3. Interference around nearby	1. Replace new battery 2. Extend the antenna on the opener 3. Get rid of interference
Can not match new transmitters	1. Memory is full 2. New transmitters are not compatible with opener	1. Press and hold on "CODE" button for more than 8 seconds until the LED flashes "C", delete all stored codes, then match new transmitters again. 2. Choose our transmitters only.
LED displays "C", opener does not work	1. Motor plug wire is loose 2. Control board is damaged	1. Re-insert motor plug wire * 2. Replace new control board
LED displays "E", opener does not work	1. Motor is damaged	1. Pull the release cord down firmly. * 2. Replace new motor
LED displays "E", after opener operates several centimeters only	1. Hall element wire plug loose between hall element and control board. 2. Hall element or control board is damaged	1. Check the wire plug * 2. Check the hall element * 3. Replace control board
The LED lamp flash, and displaying "A" flash	Opener working circles exceeds the maximum safety and need for maintenance	* Suggest you contact the maintainers to conduct security check
Note: Only the qualified professional person can carry out the maintenance marked with "*" .		

Vicway Australia Pty Ltd Limited Warranty

Vicway Australia Pty Ltd warrants to the original purchaser of the Vicway Door Openers that all parts of the Unit, other than the remote control transmitters and accessories, globes and batteries, are free from defects in materials and workmanship for a period of 60 months or 15,000 cycles (one opening and one closing action of the garage door) whichever comes first, from the date of purchase and installation in a residential premise on a specified garage door that is designed for the sole purpose of domestic use.

This Warranty is given in addition to any rights that you may have under the Australian Consumer protection laws.

Warranty Conditions

It is a condition of this Vicway Australia Pty Ltd Warranty that the Unit is sold, installed and serviced by a Qualified Installer/Dealer. Any Vicway branded garage door opener purchased on-line (over the internet) and installed by any person other than Qualified Installer/Dealer will not be covered by this Vicway Australia Pty Ltd Warranty. It is also a condition of the Vicway Australia Pty Ltd Warranty that the Unit is serviced by a Vicway Australia Pty Ltd Service Technician within the first 24 month period after the installation date and then at intervals not exceeding 24 months thereafter. Service enquiries should be directed to Vicway Australia Pty Ltd on 1300 783 591. The garage door service fee is payable by the owner.

Repairs and replacement parts provided under this Vicway Australia Pty Ltd Warranty are provided free of charge and warranted for the remaining balance of the original warranty period.

Exclusions

If our Service Technician determines that a warranty claim has been made in respect of a failure or defect arising under or out of any exclusion detailed below such that the claim is not covered under the Vicway Australia Pty Ltd Warranty, we may, subject to your other rights as a consumer, charge you a fee to repair, replace and/or return the Unit to you.

This warranty does not cover any failure of the Unit due to:

1. Non-compliance with the included instructions regarding installation, operation, maintenance and testing of the Unit or of any product with which the Unit is used.
2. Any attempt to repair, dismantle, reinstall or move the unit to another location once the unit is installed by any person other than an Authorised Installer.
3. Tampering, neglect, abuse, wear and tear, accident, electrical storm, excessive use or conditions other than normal domestic use.
4. Problems with, or relating to, the garage door or garage door hardware, including but not limited to the door springs, door rollers, door alignment or hinges.
5. Damage caused by insects or any other pests.
6. Interference caused by other radio or electrical signals
7. Problems caused by electrical faults or

replacement of batteries or light globes.

8. Water or moisture entry that causes corrosion or malfunction of electrical components.
9. Lack of proper servicing and maintenance to door, hardware and any other accessory associated with the operation of the unit.
10. Corrosion caused by sea air if located near a waterway or beach etc.
11. Installation to a commercial door or in a commercial operating application

Liability – Australia only

Under no circumstances shall the Seller be liable for consequential, incidental or special damages arising in connection with the use, or inability to use, the Unit. In no event shall the Seller's liability for damages or injury arising from law or contract or for negligence, exceed the cost of repairing or replacing the Unit or refunding the purchase price of the unit.

Under Division 2 Part V of the Trade practices act, 1974, certain warranties and conditions (Implied Terms) are implied into contracts for the supply of goods or services if the goods or services are of a kind ordinarily acquired for personal, domestic or household use or consumption. Liability for breach of those Implied Terms cannot be excluded or limited and the limitations and exclusions above do not apply to the Implied Terms.

Except for the Implied Terms and the warranties set out above, the Seller excludes all warranties and conditions implied by statute, at law, in fact or otherwise.

Note

We request that you attach your sales docket or invoice to this warranty to enable you to establish the date of purchase/installation in the unlikely event of a service call being made. It will also be required as proof of purchase and service history in the event of a claim being made against this warranty.

Failure to comply with these Terms and Conditions will void the Warranty

Contact Details

VICWAY AUSTRALIA PTY LTD
20 EARL STREET
AIRPORT WEST VIC 3042
Phone: (03) 9338 669 8
1300 783 591
Fax: (03) 9338 6639
Email: enquiries@vicway.com.au